

Display CARFAX in online listings:



This report provided free of charge by:

Victory Auto Sales, LLC

4885 Elmore Rd
Memphis, TN 38128

(901) 380-5800



Vehicle History Report™

US \$44.99

2014 DODGE CHALLENGER SXT

VIN: 2C3CDYAG5EH101103
COUPE
3.6L V6 F DOHC 24V
GASOLINE
REAR WHEEL DRIVE
Original Window Sticker

This CARFAX Report Provided
by:
Victory Auto Sales, LLC

Accident reported: minor damage

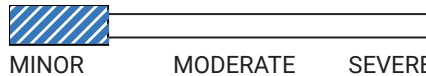

20 Service history records



3 Previous owners



Personal vehicle



147,600 Last reported odometer reading

This CARFAX Vehicle History Report is based only on information supplied to CARFAX and available as of 6/11/24 at 2:07:07 PM (CDT). Other information about this vehicle, including problems, may not have been reported to CARFAX. Use this report as one important tool, along with a vehicle inspection and test drive, to make a better decision about your next used car.



Accident / Damage History

Not all accidents / issues are reported to CARFAX

Event 1

10/21/2018

Damage reported: minor damage

Damage Severity Scale

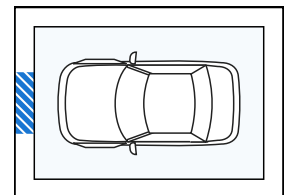
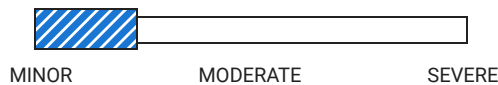

Event 2

03/10/2021

**Accident reported:
minor damage**

- Vehicle drivable
- Airbags did not deploy

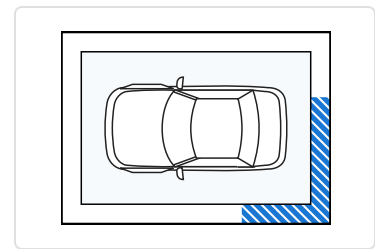
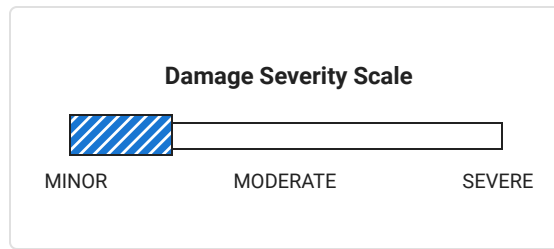







Additional History Not all accidents / issues are reported to CARFAX	Owner 1	Owner 2	Owner 3
Total Loss No total loss reported to CARFAX.	<input checked="" type="checkbox"/> No Issues Reported	<input checked="" type="checkbox"/> No Issues Reported	<input checked="" type="checkbox"/> No Issues Reported
Structural Damage CARFAX recommends that you have this vehicle inspected by a collision repair specialist.	<input checked="" type="checkbox"/> No Issues Reported	<input checked="" type="checkbox"/> No Issues Reported	<input checked="" type="checkbox"/> No Issues Reported
Airbag Deployment No airbag deployment reported to CARFAX.	<input checked="" type="checkbox"/> No Issues Reported	<input checked="" type="checkbox"/> No Issues Reported	<input checked="" type="checkbox"/> No Issues Reported
Odometer Check No indication of an odometer rollback.	<input checked="" type="checkbox"/> No Issues Indicated	<input checked="" type="checkbox"/> No Issues Indicated	<input checked="" type="checkbox"/> No Issues Indicated
Accident / Damage Damage reported: 10/21/2018. Accident reported: 03/10/2021.	<input checked="" type="checkbox"/> No Issues Reported	Minor Damage	Minor Damage
Manufacturer Recall No open recalls reported to CARFAX.	<input checked="" type="checkbox"/> No Recalls Reported	<input checked="" type="checkbox"/> No Recalls Reported	<input checked="" type="checkbox"/> No Recalls Reported
Basic Warranty Original warranty estimated to have expired.	Warranty Expired	Warranty Expired	Warranty Expired

Title History CARFAX guarantees the information in this section	Owner 1	Owner 2	Owner 3
Damage Brands Salvage Junk Rebuilt Fire Flood Hail Lemon	<input checked="" type="checkbox"/> Guaranteed No Problem	<input checked="" type="checkbox"/> Guaranteed No Problem	<input checked="" type="checkbox"/> Guaranteed No Problem
Odometer Brands Not Actual Mileage Exceeds Mechanical Limits	<input checked="" type="checkbox"/> Guaranteed No Problem	<input checked="" type="checkbox"/> Guaranteed No Problem	<input checked="" type="checkbox"/> Guaranteed No Problem





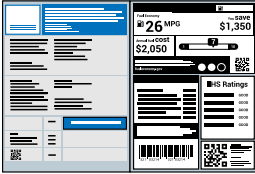





GUARANTEED - None of these title problems were reported by a U.S. state Department of Motor Vehicles (DMV). If you find that any of these title problems were reported by a DMV and not included in this report, you may qualify.
View Terms | View Certificate



 Ownership History The number of owners is estimated	Owner 1	Owner 2	Owner 3
Year purchased	2014	2015	2019
Type of owner	Personal	Personal	Personal
Estimated length of ownership	1 yr. 9 mo.	2 yrs. 5 mo.	4 yrs. 11 mo.
Owned in the following states/provinces	Texas	Texas	Tennessee
Estimated miles driven per year	10,383/yr	41,597/yr	12,523/yr
Last reported odometer reading	18,832	73,774	147,600

 Detailed History			
 Owner 1 Purchased: 2014		Low mileage! This owner drove less than the industry average of 15,000 miles per year.	Personal Vehicle 10,383 mi/yr
Date	Mileage	Source	Comments
Not Reported		FCA	Vehicle manufactured and shipped to original dealer  Original Window Sticker
08/01/2013		Dealer Inventory	Vehicle offered for sale
08/19/2013	9	Clay Cooley Chrysler Jeep Dodge Irving, TX 888-695-1564 claycooleycjd.com ★ 4.0 / 5.0 184 Verified Reviews ❤️ 1,047 Customer Favorites	 Vehicle serviced - Pre-delivery inspection completed - Safety inspection performed - Nitrogen fill tires - Vehicle washed/detailed - VIN glass etching vin etched - Emissions or safety inspection performed
12/17/2013	46	Clay Cooley Chrysler Jeep Dodge Irving, TX 855-438-5750 claycooleycjd.com ★ 4.0 / 5.0	Vehicle sold

184 Verified Reviews

 **1,047** Customer Favorites

12/19/2013	Clay Cooley Chevrolet Irving, TX 972-848-5871 claycooleychevrolet.com		Vehicle serviced
	★ 3.8 / 5.0 145 Verified Reviews		
	 1,163 Customer Favorites		
12/31/2013 56	Clay Cooley Chrysler Jeep Dodge Irving, TX 888-695-1564 claycooleycjd.com		Vehicle serviced - Window tint installed - Window(s) checked
	★ 4.0 / 5.0 184 Verified Reviews		
	 1,047 Customer Favorites		
01/10/2014	Texas Motor Vehicle Dept. Fort Worth, TX Title #05740341637083726		Title issued or updated - First owner reported - Titled or registered as personal vehicle - Loan or lien reported - Vehicle color noted as Gray
01/14/2014 763	Clay Cooley Chrysler Jeep Dodge Irving, TX 888-695-1564 claycooleycjd.com		Vehicle serviced - Maintenance inspection completed
	★ 4.0 / 5.0 184 Verified Reviews		
	 1,047 Customer Favorites		
05/14/2014 5,422	Allen Samuels East Texas Dodge Tyler, TX 903-561-2404 allensamuels.com		Vehicle serviced - Maintenance inspection completed - Oil and filter changed - Tires rotated - Engine/powertrain computer/module reprogrammed
	★ 4.5 / 5.0 28 Verified Reviews		
10/25/2014 9,425	Allen Samuels East Texas Dodge Tyler, TX 903-561-2404 allensamuels.com		Vehicle serviced - Maintenance inspection completed - Oil and filter changed - Tires rotated
	★ 4.5 / 5.0 28 Verified Reviews		

12/01/2014		Texas Motor Vehicle Dept. Fort Worth, TX Title #05740341637083726		Registration issued or renewed - Loan or lien reported - Passed safety inspection - Vehicle color noted as Gray
03/25/2015	14,009	Allen Samuels East Texas Dodge Tyler, TX 903-561-2404 allensamuels.com ★ 4.5 / 5.0 28 Verified Reviews		Vehicle serviced - Maintenance inspection completed - Oil and filter changed - Tire repaired
04/04/2015	14,449	Allen Samuels East Texas Dodge Tyler, TX 903-561-2404 allensamuels.com ★ 4.5 / 5.0 28 Verified Reviews		Vehicle serviced
09/05/2015	18,019	Allen Samuels East Texas Dodge Tyler, TX 903-561-2404 allensamuels.com ★ 4.5 / 5.0 28 Verified Reviews		Vehicle serviced - Maintenance inspection completed - Oil and filter changed
11/03/2015		Dealer Inventory		Vehicle offered for sale
11/03/2015	18,832	Texas Inspection Station Fort Worth, TX		Passed emissions inspection

**Owner 2**

Purchased: 2015

Personal Vehicle

41,597 mi/yr

Date	Mileage	Source	Comments
12/11/2015		Texas Motor Vehicle Dept. Fort Worth, TX Title #22042942339101139	Title issued or updated - New owner reported - Vehicle color noted as Gray
02/08/2017		Texas Inspection Station Fort Worth, TX	Passed emissions inspection
02/08/2017	18,950	Texas Motor Vehicle Dept.	Registration issued or renewed - Passed safety inspection

		Fort Worth, TX Title #22042942339101139	- Registration updated when owner moved the vehicle to a new location - Vehicle color noted as Gray
09/21/2017		Texas Motor Vehicle Dept. Fort Worth, TX Title #22041042989084804	Title issued or updated - Loan or lien reported - Vehicle color noted as Gray
03/01/2018	68,460	Texas Inspection Station Fort Worth, TX	Passed emissions inspection
03/01/2018		Texas Motor Vehicle Dept. Fort Worth, TX Title #22041042989084804	Registration issued or renewed - Loan or lien reported - Passed safety inspection - Vehicle color noted as Gray
05/15/2018	73,757	Texas Inspection Station Fort Worth, TX	Passed emissions inspection
06/04/2018	73,767	Dealer Inventory	Vehicle offered for sale
07/27/2018	73,774	Dealer Inventory	Vehicle offered for sale
08/02/2018		Tennessee Motor Vehicle Dept.	Vehicle purchase reported

10/21/2018

Damage Report



Damage reported: minor damage
- Damage to front



CARFAX HAS THE MOST ACCIDENT & DAMAGE

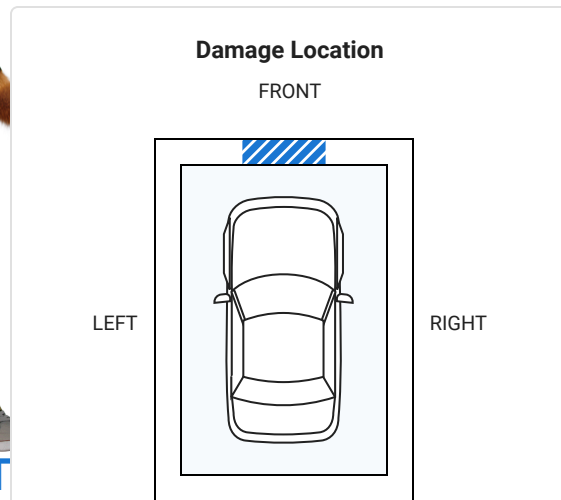
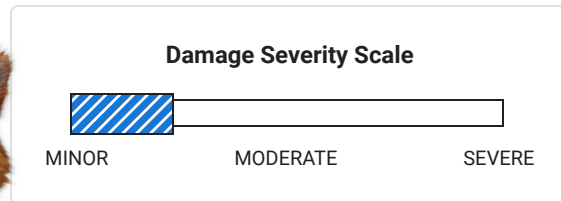

INFORMATION

REAR



Minor damage is usually cosmetic, including dents or scratches to the vehicle body.



Owner 3

Purchased: 2019



Low mileage! This owner drove less than the industry average of 15,000 miles per year.

Personal Vehicle
12,523 mi/yr

Date	Mileage	Source	Comments
03/04/2019		Tennessee Motor Vehicle Dept. Cordova, TN Title #17900143585	Title or registration issued - New owner reported - Loan or lien reported - Vehicle color noted as Gray
09/04/2019	91,912	Gateway Tire & Service Center - Cordova Cordova, TN 901-624-0911 gatewaytire.net/locations/memphis/cordova/ ★ 4.9 / 5.0 57 Verified Reviews	Vehicle serviced
07/22/2020	104,371	Take 5 Oil Change Cordova, TN 901-779-7489 https://take5oilchange.com/locations/tn/cordova-1099/ ★ 4.8 / 5.0 152 Verified Reviews ♥ 2 Customer Favorites	Vehicle serviced - Oil and filter changed
08/05/2020		Gateway Tire & Service Center - Cordova Cordova, TN 901-624-0911 gatewaytire.net/locations/memphis/cordova/ ★ 4.9 / 5.0 57 Verified Reviews	Vehicle serviced - Tire(s) replaced
10/20/2020	107,369	Take 5 Oil Change Cordova, TN 901-779-7489 https://take5oilchange.com/locations/tn/cordova-	Vehicle serviced - Antifreeze/coolant flushed/changed

1099/

★ 4.8 / 5.0

152 Verified Reviews

♥ 2 Customer Favorites

03/10/2021

Damage Report



Accident reported: minor damage

- Damage to rear
- Damage to left rear
- Vehicle drivable
- Airbags did not deploy



CARFAX HAS THE MOST ACCIDENT & DAMAGE INFORMATION

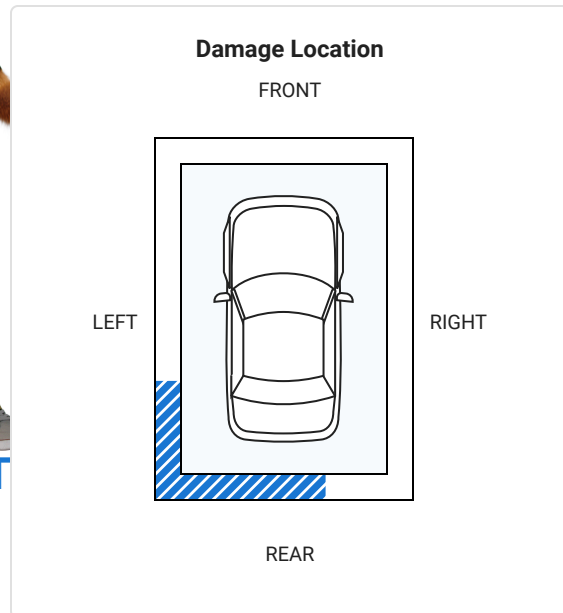
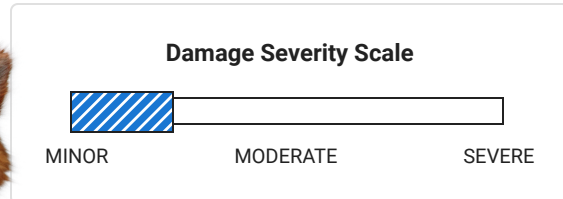

Minor damage is usually cosmetic, including dents or scratches to the vehicle body.

03/16/2021 111,855

Gateway Tire & Service Center - Cordova
Cordova, TN
901-624-0911
gatewaytire.net/locations/memphis/cordova/



Vehicle serviced

- Tire(s) replaced

★ 4.9 / 5.0





57 Verified Reviews

03/16/2021

Tennessee Motor Vehicle Dept.
Cordova, TN
Title #17900143585

Registration issued or renewed

- Correction to record
- Loan or lien reported
- Vehicle color noted as Gray

04/23/2021	113,335	Take 5 Oil Change Cordova, TN 901-779-7489 https://take5oilchange.com/locations/tn/cordova-1099/ ★ 4.8 / 5.0 152 Verified Reviews ♥ 2 Customer Favorites		Vehicle serviced - Oil and filter changed
06/17/2021	115,492	Gateway Tire & Service Center - Cordova Cordova, TN 901-624-0911 gatewaytire.net/locations/memphis/cordova/ ★ 4.9 / 5.0 57 Verified Reviews		Vehicle serviced - Antifreeze/coolant flushed/changed
04/29/2022	129,919	Take 5 Oil Change Cordova, TN 901-779-7489 https://take5oilchange.com/locations/tn/cordova-1099/ ★ 4.8 / 5.0 152 Verified Reviews ♥ 2 Customer Favorites		Vehicle serviced - Oil and filter changed
05/02/2022		Tennessee Motor Vehicle Dept. Cordova, TN Title #17900143585		Registration issued or renewed - Loan or lien reported - Vehicle color noted as Gray
12/27/2022	140,963	Gossett Motor Cars Memphis, TN 888-482-5202 https://gossettmotors.com ★ 4.3 / 5.0 117 Verified Reviews ♥ 2,983 Customer Favorites		Vehicle serviced
01/19/2023	141,986	Gossett Motor Cars Memphis, TN 888-482-5202 https://gossettmotors.com ★ 4.3 / 5.0 117 Verified Reviews		Vehicle serviced - 5,000 mile service performed - Oil and filter changed

♥ 2,983 Customer Favorites

02/13/2024 147,600 Wolfchase Chrysler
Dodge Jeep
Bartlett, TN
901-373-3030
wolfchasecdj.com/



Vehicle serviced
- Engine checked

★ 4.4 / 5.0
31 Verified Reviews



Looks like this dealer serviced the car in order to prepare it for sale. That's a good thing!

02/14/2024 Wolfchase Chrysler
Dodge Jeep
Bartlett, TN
901-373-3030
wolfchasecdj.com/

★ 4.4 / 5.0
31 Verified Reviews

Vehicle offered for sale

Have Questions? Consumers, please visit our Help Center at www.carfax.com. Dealers or Subscribers, please visit our Help Center at www.carfaxonline.com.



Glossary

Accident Indicator

CARFAX receives information about accidents in all 50 states, the District of Columbia and Canada.

Not every accident is reported to CARFAX. As details about the accident become available, those additional details are added to the CARFAX Vehicle History Report. CARFAX recommends that you have this vehicle inspected by a qualified mechanic.

- According to the National Safety Council, Injury Facts, 2021 edition, 5% of the 276 million registered vehicles in the U.S. were involved in an accident in 2019. Over 77% of these were considered minor or moderate.
- This CARFAX Vehicle History Report is based only on information supplied to CARFAX and available as of 6/11/24 at 2:07:07 PM (CDT). Other information about this vehicle, including problems, may not have been reported to CARFAX. Use this report as one important tool, along with a vehicle inspection and test drive, to make a better decision about your next used car.

Damage Indicator

Damage can be a result of many different types of events. Examples include contact with objects (other cars, trees, traffic signs, road debris, etc), vandalism, or weather-related events. Not every damage event is reported to CARFAX. As details about the damage event become available, those additional details are added to the CARFAX Vehicle History Report. CARFAX recommends that you have this vehicle inspected by a qualified mechanic.

- This CARFAX Vehicle History Report is based only on information supplied to CARFAX and available as of 6/11/24 at 2:07:07 PM (CDT). Other information about this vehicle, including problems, may not have been reported to CARFAX. Use this report as one important tool, along with a vehicle inspection and test drive, to make a better decision about your next used car.

Damage Severity

Damage events result in one of the following severity levels:

- Minor: Generally, minor damage is cosmetic (including dents or scratches), may only require reconditioning, and typically does not compromise a vehicle's operation and/or safety.
- Moderate: Moderate damage may affect multiple components of the vehicle and may impair the vehicle's operation and/or safety.
- Severe: Severe damage usually affects multiple components of the vehicle and is likely to compromise the vehicle's operation and/or safety.

CARFAX recommends getting a pre-purchase inspection at a certified collision repair facility.

First Owner

When the first owner(s) obtains a title from a Department of Motor Vehicles as proof of ownership.

New Owner Reported

When a vehicle is sold to a new owner, the Title must be transferred to the new owner(s) at a Department of Motor Vehicles.

Ownership History

CARFAX defines an owner as an individual or business that possesses and uses a vehicle. Not all title transactions represent changes in ownership. To provide estimated number of owners, CARFAX proprietary technology analyzes all the events in a vehicle history. Estimated ownership is available for vehicles manufactured after 1991 and titled solely in the US including Puerto Rico. Dealers sometimes opt to take ownership of a vehicle and are required to in the following states: Maine, Massachusetts, New Jersey, Ohio, Oklahoma, Pennsylvania and South Dakota. Please consider this as you review a vehicle's estimated ownership history.

Title Issued

A state issues a title to provide a vehicle owner with proof of ownership. Each title has a unique number. Each title or registration record on a CARFAX report does not necessarily indicate a change in ownership. In Canada, a registration and bill of sale are used as proof of ownership.

Follow Us:  facebook.com/CARFAX  [@CARFAXinc](https://twitter.com/CARFAXinc)  [About CARFAX](#)

CARFAX DEPENDS ON ITS SOURCES FOR THE ACCURACY AND RELIABILITY OF ITS INFORMATION. THEREFORE, NO RESPONSIBILITY IS ASSUMED BY CARFAX OR ITS AGENTS FOR ERRORS OR OMISSIONS IN THIS REPORT. CARFAX FURTHER EXPRESSLY DISCLAIMS ALL WARRANTIES, EXPRESS OR IMPLIED, INCLUDING ANY IMPLIED WARRANTIES OF MERCHANTABILITY OR FITNESS FOR A PARTICULAR PURPOSE.

© 2024 CARFAX, Inc., part of S&P Global. All rights reserved.
6/11/24 2:07:07 PM (CDT)

I have reviewed and received a copy of the CARFAX Vehicle History Report for this 2014 DODGE CHALLENGER vehicle (VIN: 2C3CDYAG5EH101103), which is based on information supplied to CARFAX and available as of 6/11/24 at 3:07 PM (EDT).

Customer Signature

Date

Dealer Signature

Date