

Display CARFAX in online listings:



This report provided free of charge by:

Victory Auto Sales, LLC

4885 Elmore Rd
Memphis, TN 38128

(901) 380-5800



Vehicle History Report™

US \$44.99

2009 NISSAN FRONTIER SE V6

VIN: 1N6AD07U19C424619
CREW PICKUP
4.0L V6 F DOHC 24V
GASOLINE
REAR WHEEL DRIVE

This CARFAX Report Provided
by:
Victory Auto Sales, LLC

Damage reported: minor damage



 **20** Service history records

 At least 1 open recall

 **2** Previous owners

 **77,762** Last reported odometer reading



This CARFAX Vehicle History Report is based only on information supplied to CARFAX and available as of 9/6/23 at 11:45:30 AM (CDT). Other information about this vehicle, including problems, may not have been reported to CARFAX. Use this report as one important tool, along with a vehicle inspection and test drive, to make a better decision about your next used car.







Ownership History





The number of owners is estimated

	Owner 1	Owner 2
Year purchased	2009	2023
Type of owner	Personal	Personal
Estimated length of ownership	13 yrs. 11 mo.	1 month
Owned in the following states/provinces	Tennessee	Tennessee
Estimated miles driven per year	6,766/yr	---
Last reported odometer reading	61,098	77,762

 Title History CARFAX guarantees the information in this section	Owner 1	Owner 2
Damage Brands Salvage Junk Rebuilt Fire Flood Hail Lemon	<input checked="" type="checkbox"/> Guaranteed No Problem	<input checked="" type="checkbox"/> Guaranteed No Problem
Odometer Brands Not Actual Mileage Exceeds Mechanical Limits	<input checked="" type="checkbox"/> Guaranteed No Problem	<input checked="" type="checkbox"/> Guaranteed No Problem
 GUARANTEED - None of these major title problems were reported by a state Department of Motor Vehicles (DMV). If you find that any of these title problems were reported by a DMV and not included in this report, CARFAX will buy this vehicle back. View Terms View Certificate		

 Additional History Not all accidents / issues are reported to CARFAX	Owner 1	Owner 2
Total Loss No total loss reported to CARFAX.	<input checked="" type="checkbox"/> No Issues Reported	<input checked="" type="checkbox"/> No Issues Reported
Structural Damage CARFAX recommends that you have this vehicle inspected by a collision repair specialist.	<input checked="" type="checkbox"/> No Issues Reported	<input checked="" type="checkbox"/> No Issues Reported
Airbag Deployment No airbag deployment reported to CARFAX.	<input checked="" type="checkbox"/> No Issues Reported	<input checked="" type="checkbox"/> No Issues Reported
Odometer Check No indication of an odometer rollback.	<input checked="" type="checkbox"/> No Issues Indicated	<input checked="" type="checkbox"/> No Issues Indicated
Accident / Damage Damage reported: 09/17/2018 and 01/31/2023.	Minor Damage	No New Issues Reported
Manufacturer Recall At least 1 manufacturer recall requires service. Locate an authorized Nissan dealer near you to schedule an appointment.	Recall Reported	No New Recalls Reported
Basic Warranty Original warranty estimated to have expired.	Warranty Expired	Warranty Expired

 Detailed History			
 Owner 1 Purchased: 2009		<div style="border: 1px solid blue; padding: 5px;">Low mileage! This owner drove less than the industry average of 15,000 miles per year.</div>	Personal Vehicle 6,766 mi/yr
Date	Mileage	Source	Comments
07/07/2009		NICB	Vehicle manufactured and shipped to Tennessee

07/15/2009		<p>Jim Keras Nissan Memphis, TN 901-373-2800 jimkerasnissan.com/</p> <p>★ 4.6 / 5.0 493 Verified Reviews ❤️ 1,752 Customer Favorites</p>	<p> Vehicle serviced - Pre-delivery inspection completed - Nitrogen fill tires - Spare tire lock installed - Wheel locks installed</p>
07/17/2009		<p>Jim Keras Subaru Memphis, TN 901-373-2700 subarumemphis.com/</p> <p>★ 4.8 / 5.0 230 Verified Reviews ❤️ 798 Customer Favorites</p>	<p> Vehicle serviced - Vehicle washed/detailed</p>
08/24/2009		<p>Jim Keras Nissan Memphis, TN 901-373-2800 jimkerasnissan.com/</p> <p>★ 4.6 / 5.0 493 Verified Reviews ❤️ 1,752 Customer Favorites</p>	<p>Vehicle sold</p>
08/24/2009	32	<p>Tennessee Motor Vehicle Dept.</p>	<p>Vehicle purchase reported - Titled or registered as personal vehicle</p>
08/24/2009	1	<p>CareGard Warranty Services, Inc. Memphis, TN afgcompanies.com</p>	<p>Service contract issued</p>
08/25/2009	33	<p>Jim Keras Subaru Memphis, TN 901-373-2700 subarumemphis.com/</p> <p>★ 4.8 / 5.0 230 Verified Reviews ❤️ 798 Customer Favorites</p>	<p> Vehicle serviced - Vehicle washed/detailed</p>
09/12/2009	1,046	<p>Jim Keras Nissan Memphis, TN 901-373-2800 jimkerasnissan.com/</p> <p>★ 4.6 / 5.0 493 Verified Reviews ❤️ 1,752 Customer Favorites</p>	<p> Vehicle serviced - Evaporative emissions vent purge valve replaced - Engine/powertrain computer/module checked</p>
10/07/2009		<p>Tennessee Motor Vehicle Dept.</p>	<p>Title or registration issued - First owner reported</p>

Memphis, TN
Title #79976245

- Loan or lien reported

12/26/2009 5,942

Jim Keras Nissan
Memphis, TN
901-373-2800
jimkerasnissan.com/

★ 4.6 / 5.0
493 Verified Reviews
Customer Favorites
♥ 1,752



Vehicle serviced

- Maintenance inspection completed
- Vehicle washed/detailed
- Oil and filter changed

09/16/2010 13,459

Jim Keras Nissan
Memphis, TN
901-373-2800
jimkerasnissan.com/

★ 4.6 / 5.0
493 Verified Reviews
Customer Favorites
♥ 1,752



Vehicle serviced

- Maintenance inspection completed
- Vehicle washed/detailed
- Four wheel alignment performed
- Brakes checked
- Oil and filter changed
- Tires rotated
- Tire condition and pressure checked

01/04/2011 18,244

Jim Keras Nissan
Memphis, TN
901-373-2800
jimkerasnissan.com/

★ 4.6 / 5.0
493 Verified Reviews
Customer Favorites
♥ 1,752



Vehicle serviced

- Maintenance inspection completed
- Air filter replaced
- Oil and filter changed
- Cabin air filter replaced/cleaned

05/17/2011 22,334

Jim Keras Nissan
Memphis, TN
901-373-2800
jimkerasnissan.com/

★ 4.6 / 5.0
493 Verified Reviews
Customer Favorites
♥ 1,752



Vehicle serviced

- Maintenance inspection completed
- Oil and filter changed
- Four wheel alignment performed
- Tire condition and pressure checked
- Brakes checked
- Vehicle washed/detailed
- Tires rotated

10/14/2011 26,765

Jim Keras Nissan
Memphis, TN
901-373-2800
jimkerasnissan.com/

★ 4.6 / 5.0
493 Verified Reviews
Customer Favorites
♥ 1,752



Vehicle serviced

- Maintenance inspection completed
- Oil and filter changed
- Tire condition and pressure checked
- Brakes checked
- Vehicle washed/detailed
- Tire repaired

11/01/2011

Tennessee
Motor Vehicle Dept.
Memphis, TN
Title #79976245

Registration issued or renewed

- Loan or lien reported
- Vehicle color noted as Gray



03/14/2012 30,343





Jim Keras Nissan
Memphis, TN



Vehicle serviced

- Maintenance inspection completed

		<p>901-373-2800 jimkerasnissan.com/ ★ 4.6 / 5.0 493 Verified Reviews ♥ 1,752 Customer Favorites</p>	<ul style="list-style-type: none"> - Brakes checked - Oil and filter changed - Tires rotated - Differential serviced - Antifreeze/coolant flushed/changed - Vehicle washed/detailed
08/18/2012	33,076	<p>Jim Keras Nissan Memphis, TN 901-373-2800 jimkerasnissan.com/ ★ 4.6 / 5.0 493 Verified Reviews ♥ 1,752 Customer Favorites</p>	 <p>Vehicle serviced</p> <ul style="list-style-type: none"> - Maintenance inspection completed - Battery replaced - Vehicle washed/detailed - Oil and filter changed - Battery/charging system checked - Battery charged
10/12/2013		<p>Tennessee Motor Vehicle Dept. Memphis, TN Title #79976245</p>	<p>Registration issued or renewed</p> <ul style="list-style-type: none"> - Loan or lien reported - Vehicle color noted as Gray
01/21/2014	39,066	<p>Jim Keras Nissan Memphis, TN 901-373-2800 jimkerasnissan.com/ ★ 4.6 / 5.0 493 Verified Reviews ♥ 1,752 Customer Favorites</p>	 <p>Vehicle serviced</p> <ul style="list-style-type: none"> - Maintenance inspection completed - Four wheel alignment performed - Oil and filter changed - Vehicle washed/detailed
05/29/2014		<p>Tennessee Motor Vehicle Dept. Memphis, TN Title #79976245</p>	<p>Loan or lien released</p> <ul style="list-style-type: none"> - Vehicle color noted as Gray
10/16/2014		<p>Tennessee Motor Vehicle Dept. Memphis, TN Title #79976245</p>	<p>Registration issued or renewed</p> <ul style="list-style-type: none"> - Vehicle color noted as Gray
07/20/2015	44,483	<p>Jim Keras Nissan Memphis, TN 901-373-2800 jimkerasnissan.com/ ★ 4.6 / 5.0 493 Verified Reviews ♥ 1,752 Customer Favorites</p>	 <p>Vehicle serviced</p> <ul style="list-style-type: none"> - Maintenance inspection completed - Vehicle washed/detailed - Oil and filter changed
10/28/2015		<p>Tennessee Motor Vehicle Dept. Memphis, TN Title #79976245</p>	<p>Registration issued or renewed</p> <ul style="list-style-type: none"> - Vehicle color noted as Gray

03/23/2016	47,175	<p>Jim Keras Nissan Memphis, TN 901-373-2800 jimkerasnissan.com/</p> <p>★ 4.6 / 5.0 493 Verified Reviews ❤️ 1,752 Customer Favorites</p>	 <p>Vehicle serviced - Battery replaced - Front wiper blades/refills replaced</p>
04/04/2016	47,434	<p>Jim Keras Nissan Memphis, TN 901-373-2800 jimkerasnissan.com/</p> <p>★ 4.6 / 5.0 493 Verified Reviews ❤️ 1,752 Customer Favorites</p>	 <p>Vehicle serviced - High mount brake light bulb replaced</p>
09/16/2016	49,799	<p>Jim Keras Nissan Memphis, TN 901-373-2800 jimkerasnissan.com/</p> <p>★ 4.6 / 5.0 493 Verified Reviews ❤️ 1,752 Customer Favorites</p>	 <p>Vehicle serviced - Maintenance inspection completed - Oil and filter changed</p>
10/10/2016		<p>Tennessee Motor Vehicle Dept. Memphis, TN Title #79976245</p>	<p>Registration issued or renewed - Vehicle color noted as Gray</p>
05/08/2017	53,361	<p>Jim Keras Nissan Memphis, TN 901-373-2800 jimkerasnissan.com/</p> <p>★ 4.6 / 5.0 493 Verified Reviews ❤️ 1,752 Customer Favorites</p>	 <p>Vehicle serviced - Maintenance inspection completed - Vehicle washed/detailed - Oil and filter changed</p>
10/25/2017	56,193	<p>Jim Keras Nissan Memphis, TN 901-373-2800 jimkerasnissan.com/</p> <p>★ 4.6 / 5.0 493 Verified Reviews ❤️ 1,752 Customer Favorites</p>	 <p>Vehicle serviced - Maintenance inspection completed - Vehicle washed/detailed - Blend/diverter door actuator replaced</p>
10/27/2017		<p>Tennessee Motor Vehicle Dept. Memphis, TN Title #79976245</p>	<p>Registration issued or renewed - Vehicle color noted as Gray</p>

08/31/2018 61,098

Sears Auto Center
Memphis, TN
901-346-3428
searsauto.com

★ 4.5 / 5.0
184 Verified Reviews



Vehicle serviced

- Tire(s) replaced
- Oil and filter changed
- Fluids checked
- Tire(s) balanced

09/17/2018

Damage Report



Damage reported: minor damage

- Damage to left front
- Damage to front



**CARFAX HAS THE MOST
ACCIDENT & DAMAGE
INFORMATION**

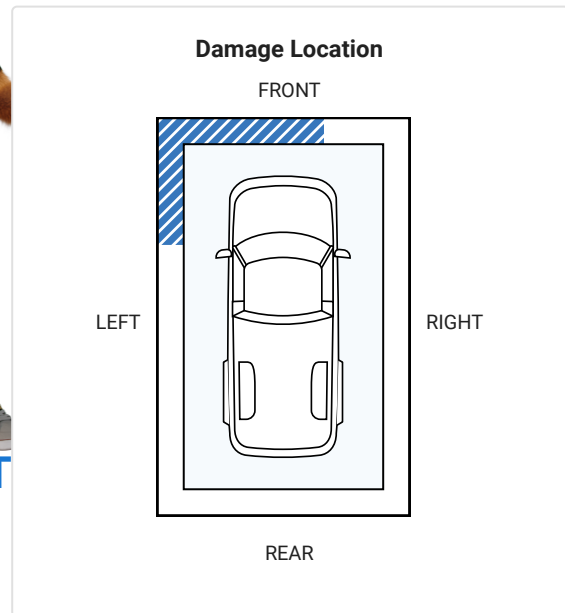
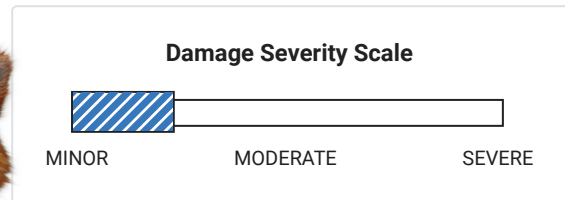

Minor damage is usually cosmetic, including dents or scratches to the vehicle body.

10/26/2018

Tennessee
Motor Vehicle Dept.
Memphis, TN
Title #79976245

Registration issued or renewed

- Vehicle color noted as Gray

10/08/2019

Tennessee
Motor Vehicle Dept.
Memphis, TN
Title #79976245

Registration issued or renewed

- Vehicle color noted as Gray

10/21/2020

Tennessee
Motor Vehicle Dept.
Memphis, TN

Registration issued or renewed

- Vehicle color noted as Gray

Title #79976245

10/21/2021

Tennessee
Motor Vehicle Dept.
Memphis, TN
Title #79976245

Registration issued or renewed
- Vehicle color noted as Gray

10/10/2022

Tennessee
Motor Vehicle Dept.
Memphis, TN
Title #79976245

Registration issued or renewed
- Vehicle color noted as Gray

01/31/2023

Damage Report



Damage reported: minor damage
- Damage to left front



**CARFAX HAS THE MOST
ACCIDENT & DAMAGE
INFORMATION**

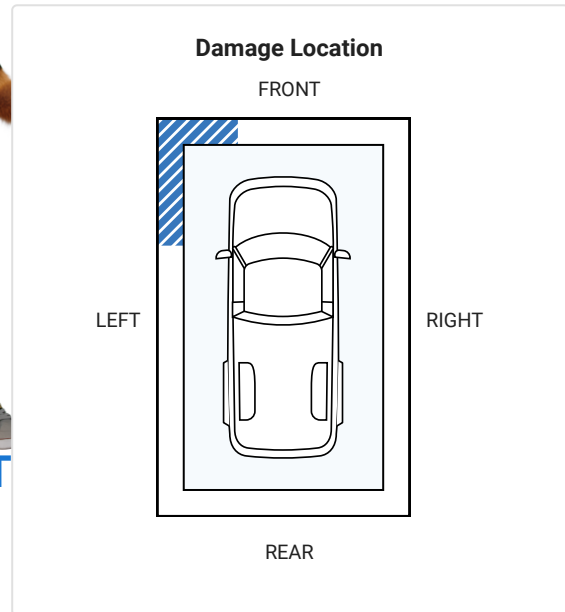
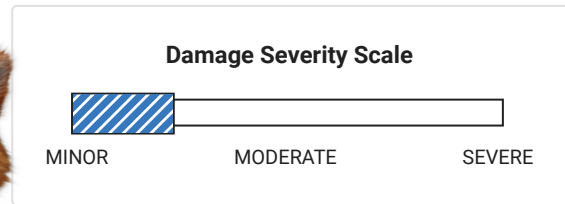

Minor damage is usually cosmetic, including dents or scratches to the vehicle body.

02/09/2023

Nissan North America
Inc.

Manufacturer Safety recall issued
- NHTSA #23V-067
- Recall #PC945 PTH FTR XTR DR AB EB
NO RPR
- Status: Remedy Not Yet Available

Locate an authorized Nissan dealer
near you to obtain more information
about this recall

⊖ Learn more about this recall

Description: THE RESIN EMBLEM ON THE DRIVER S AIRBAG MODULE COVER IN AFFECTED VEHICLES MAY HAVE REDUCED DURABILITY DUE TO POTENTIAL SUPPLIER PRODUCTION PROCESS VARIATION. IN THIS CONDITION, OVER TIME THE POSTS OF THE EMBLEM MAY DEVELOP CRACKS, AND THE EMBLEM AND RETAINER COMPONENTS COULD DETACH IN THE EVENT OF AN AIRBAG DEPLOYMENT.

A DETACHED EMBLEM AND/OR RETAINER COMPONENT MAY BECOME A PROJECTILE DURING AN AIRBAG DEPLOYMENT, INCREASING THE RISK OF INJURY TO VEHICLE OCCUPANTS.

Remedy: NISSAN IS CURRENTLY DEVELOPING A REMEDY PLAN.



Owner 2

Purchased: 2023

Personal Vehicle

Date	Mileage	Source	Comments
07/25/2023		Tennessee Motor Vehicle Dept. Memphis, TN	Vehicle purchase reported - Registration issued or renewed - New owner reported - Vehicle color noted as Black
07/26/2023	77,762	Jim Keras Nissan Memphis, TN 901-373-2800 jimkerasnissan.com/ ★ 4.6 / 5.0 493 Verified Reviews ❤️ 1,752 Customer Favorites	 Vehicle serviced

Have Questions? Consumers, please visit our Help Center at www.carfax.com. Dealers or Subscribers, please visit our Help Center at www.carfaxonline.com.



Glossary

Damage Indicator

Damage can be a result of many different types of events. Examples include contact with objects (other cars, trees, traffic signs, road debris, etc), vandalism, or weather-related events. Not every damage event is reported to CARFAX. As details about the damage event become available, those additional details are added to the CARFAX Vehicle History Report. CARFAX recommends that you have this vehicle inspected by a qualified mechanic.

- This CARFAX Vehicle History Report is based only on information supplied to CARFAX and available as of 9/6/23 at 11:45:30 AM (CDT). Other information about this vehicle, including problems, may not have been reported to CARFAX. Use this report as one important tool, along with a vehicle inspection and test drive, to make a better decision about your next used car.

Damage Severity

Damage events result in one of the following severity levels:

- Minor: Generally, minor damage is cosmetic (including dents or scratches), may only require reconditioning, and typically does not compromise a vehicle's operation and/or safety.

- Moderate: Moderate damage may affect multiple components of the vehicle and may impair the vehicle's operation and/or safety.
- Severe: Severe damage usually affects multiple components of the vehicle and is likely to compromise the vehicle's operation and/or safety.

CARFAX recommends getting a pre-purchase inspection at a certified collision repair facility.

First Owner

When the first owner(s) obtains a title from a Department of Motor Vehicles as proof of ownership.

Manufacturer Recall

Automobile manufacturers issue recall notices to inform vehicle owners of a safety defect or failure to meet minimum federal safety or emissions standards. Manufacturer recalls are repaired at no cost to the customer.

New Owner Reported

When a vehicle is sold to a new owner, the Title must be transferred to the new owner(s) at a Department of Motor Vehicles.

Ownership History

CARFAX defines an owner as an individual or business that possesses and uses a vehicle. Not all title transactions represent changes in ownership. To provide estimated number of owners, CARFAX proprietary technology analyzes all the events in a vehicle history. Estimated ownership is available for vehicles manufactured after 1991 and titled solely in the US including Puerto Rico. Dealers sometimes opt to take ownership of a vehicle and are required to in the following states: Maine, Massachusetts, New Jersey, Ohio, Oklahoma, Pennsylvania and South Dakota. Please consider this as you review a vehicle's estimated ownership history.

Follow Us:



facebook.com/CARFAX



[@CARFAXinc](https://twitter.com/CARFAXinc)



About CARFAX

CARFAX DEPENDS ON ITS SOURCES FOR THE ACCURACY AND RELIABILITY OF ITS INFORMATION. THEREFORE, NO RESPONSIBILITY IS ASSUMED BY CARFAX OR ITS AGENTS FOR ERRORS OR OMISSIONS IN THIS REPORT. CARFAX FURTHER EXPRESSLY DISCLAIMS ALL WARRANTIES, EXPRESS OR IMPLIED, INCLUDING ANY IMPLIED WARRANTIES OF MERCHANTABILITY OR FITNESS FOR A PARTICULAR PURPOSE.

© 2023 CARFAX, Inc., part of S&P Global. All rights reserved.
9/6/23 11:45:30 AM (CDT)

I have reviewed and received a copy of the CARFAX Vehicle History Report for this 2009 NISSAN FRONTIER vehicle (VIN: 1N6AD07U19C424619), which is based on information supplied to CARFAX and available as of 9/6/23 at 12:45 PM (EDT).

Customer Signature

Date

Dealer Signature

Date