

Display CARFAX in online listings:



This report provided free of charge by:

Victory Auto Sales, LLC

4885 Elmore Rd
Memphis, TN 38128

(901) 380-5800



Vehicle History Report™

US \$44.99

2014 RAM C/V TRADESMAN

VIN: 2C4JRGAG0ER148130
CARGO VAN
3.6L V6 F DOHC 24V
GASOLINE
FRONT WHEEL DRIVE
Original Window Sticker

This CARFAX Report Provided
by:
Victory Auto Sales, LLC



Accident reported



22 Service history records



CARFAX 1-Owner vehicle



Commercial vehicle



Last owned in Tennessee



123,002 Last reported odometer reading

This CARFAX Vehicle History Report is based only on information supplied to CARFAX and available as of 7/25/23 at 11:41:21 AM (CDT). Other information about this vehicle, including problems, may not have been reported to CARFAX. Use this report as one important tool, along with a vehicle inspection and test drive, to make a better decision about your next used car.



Ownership History

The number of owners is estimated

Owner 1

Year purchased

2015

Type of owner

Commercial

Estimated length of ownership

7 yrs. 7 mo.

Owned in the following states/provinces

Tennessee



Estimated miles driven per year

18,711/yr



Last reported odometer reading

123,002





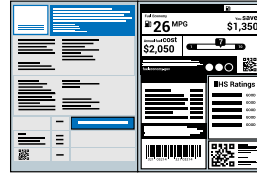

 Title History CARFAX guarantees the information in this section	Owner 1
Damage Brands Salvage Junk Rebuilt Fire Flood Hail Lemon	<input checked="" type="checkbox"/> Guaranteed No Problem
Odometer Brands Not Actual Mileage Exceeds Mechanical Limits	<input checked="" type="checkbox"/> Guaranteed No Problem
 GUARANTEED - None of these major title problems were reported by a state Department of Motor Vehicles (DMV). If you find that any of these title problems were reported by a DMV and not included in this report, CARFAX will buy this vehicle back. View Terms View Certificate	

 Additional History Not all accidents / issues are reported to CARFAX	Owner 1
Total Loss No total loss reported to CARFAX.	<input checked="" type="checkbox"/> No Issues Reported
Structural Damage CARFAX recommends that you have this vehicle inspected by a collision repair specialist.	<input checked="" type="checkbox"/> No Issues Reported
Airbag Deployment No airbag deployment reported to CARFAX.	<input checked="" type="checkbox"/> No Issues Reported
Odometer Check No indication of an odometer rollback.	<input checked="" type="checkbox"/> No Issues Indicated
Accident / Damage Accident reported: 12/16/2021. Damage reported: 02/11/2022.	Accident Reported
Manufacturer Recall Check with an authorized RAM dealer for any open recalls.	<input checked="" type="checkbox"/> No Recalls Reported
Basic Warranty Original warranty estimated to have expired.	Warranty Expired

 Detailed History			
 Owner 1 Purchased: 2015		Commercial Vehicle 18,711 mi/yr	
Date	Mileage	Source	Comments
Not Reported		FCA	Vehicle manufactured and shipped to original dealer



Original Window Sticker

10/04/2013	15	Laura Chevrolet Buick GMC of Sullivan Sullivan, MO 573-468-3178 laurachevybg.com/ ★ 5.0 / 5.0 6 Verified Reviews		Vehicle serviced - Nitrogen fill tires
10/17/2013		Dealer Inventory		Vehicle offered for sale
10/03/2014		Laura Chevrolet Buick GMC of Sullivan Sullivan, MO 573-468-3178 laurachevybg.com/ ★ 5.0 / 5.0 6 Verified Reviews		Vehicle serviced
04/03/2015		Dealer Inventory		Vehicle offered for sale
05/06/2015		Laura Chrysler Dodge Jeep Ram of Sullivan Sullivan, MO 573-468-5300 lauracdjr.com/		Vehicle serviced - Battery replaced
05/20/2015		Laura Ford of Sullivan Sullivan, MO 573-468-4100 laurafordofsullivan.com ♥ 1 Customer Favorite		Vehicle serviced
12/04/2015	1,098	Tennessee Motor Vehicle Dept.		Vehicle purchase reported
12/07/2015		Tennessee Motor Vehicle Dept. Memphis, TN Title #96564239		Title or registration issued - First owner reported - Loan or lien reported - Titled or registered as commercial vehicle - Vehicle color noted as White
06/28/2016	11,771	Homer Skelton Chrysler Dodge Jeep Millington, TN 901-872-0195		Vehicle serviced - Maintenance inspection completed - Computer reprogrammed

homerskeltonchryslerdod
gejeep.com

★ 4.7 / 5.0

277 Verified Reviews

♥ 2,510 Customer
Favorites

08/23/2016 17,456

Valvoline Instant Oil
Change
Cordova, TN
901-751-8451
vioc.com



Vehicle serviced

- Air filter replaced
- Oil and filter changed

★ 4.6 / 5.0

154 Verified Reviews

♥ 233 Customer Favorites

10/31/2016 21,418

Homer Skelton Chrysler
Dodge Jeep
Millington, TN
901-872-0195
homerskeltonchryslerdod
gejeep.com



Vehicle serviced

- Maintenance inspection completed
- Oil and filter changed

★ 4.7 / 5.0

277 Verified Reviews

♥ 2,510 Customer
Favorites

01/31/2017 27,622

Homer Skelton Chrysler
Dodge Jeep
Millington, TN
901-872-0195
homerskeltonchryslerdod
gejeep.com



Vehicle serviced

- Maintenance inspection completed
- Oil and filter changed

★ 4.7 / 5.0

277 Verified Reviews

♥ 2,510 Customer
Favorites

04/14/2017 34,025

Homer Skelton Chrysler
Dodge Jeep
Millington, TN
901-872-0195
homerskeltonchryslerdod
gejeep.com



Vehicle serviced

- Maintenance inspection completed
- Oil and filter changed

★ 4.7 / 5.0

277 Verified Reviews

♥ 2,510 Customer
Favorites

05/05/2017

Raleigh Tire - Memphis
Memphis, TN
901-386-6211
raleightire.com/



Vehicle serviced

- Tires rotated
- Tire condition and pressure checked
- Tire(s) replaced

★ 4.6 / 5.0

20 Verified Reviews

 **23** Customer Favorites

08/02/2017 43,309

Homer Skelton Chrysler
Dodge Jeep
Millington, TN
901-872-0195
homerskeltonchryslerdod
gejeep.com

 **4.7 / 5.0**

277 Verified Reviews

 **2,510** Customer
Favorites



Vehicle serviced

- Maintenance inspection completed
- Oil and filter changed

01/08/2019 75,717

Valvoline Instant Oil
Change
Bartlett, TN
901-213-0310
vioc.com

 **4.7 / 5.0**

129 Verified Reviews

 **182** Customer Favorites



Vehicle serviced

- Oil and filter changed

05/23/2019 79,741

Raleigh Tire - Memphis
Memphis, TN
901-386-6211
raleightire.com/

 **4.6 / 5.0**

20 Verified Reviews

 **23** Customer Favorites



Vehicle serviced

- Tire(s) replaced
- Tire(s) balanced
- Tires rotated
- Tire condition and pressure checked

07/10/2019 81,381

Valvoline Instant Oil
Change
Bartlett, TN
901-213-0310
vioc.com

 **4.7 / 5.0**

129 Verified Reviews

 **182** Customer Favorites



Vehicle serviced

- Oil and filter changed

09/30/2019 84,669

Valvoline Instant Oil
Change
Bartlett, TN
901-213-0310
vioc.com

 **4.7 / 5.0**

129 Verified Reviews

 **182** Customer Favorites



Vehicle serviced





- Oil and filter changed

12/04/2019

Tennessee
Motor Vehicle Dept.
Memphis, TN

Registration issued or renewed

- Loan or lien reported

		Title #96564239		- Titled or registered as commercial vehicle - Vehicle color noted as White
03/10/2020	90,358	Valvoline Instant Oil Change Bartlett, TN 901-213-0310 vioc.com ★ 4.7 / 5.0 129 Verified Reviews ♥ 182 Customer Favorites		Vehicle serviced - Oil and filter changed
10/07/2020	100,448	Valvoline Instant Oil Change Bartlett, TN 901-213-0310 vioc.com ★ 4.7 / 5.0 129 Verified Reviews ♥ 182 Customer Favorites		Vehicle serviced - Oil and filter changed
11/01/2020		Tennessee Motor Vehicle Dept. Memphis, TN Title #96564239		Title or registration issued - Loan or lien reported - Titled or registered as commercial vehicle - Vehicle color noted as White
01/21/2021		Tennessee Motor Vehicle Dept. Memphis, TN Title #96564239		Registration issued or renewed - Loan or lien reported - Titled or registered as commercial vehicle - Vehicle color noted as White
03/12/2021	105,694	Valvoline Instant Oil Change Southaven, MS 662-349-3345 vioc.com ★ 4.7 / 5.0 133 Verified Reviews ♥ 206 Customer Favorites		Vehicle serviced - Oil and filter changed
04/28/2021	107,887	Raleigh Tire - Memphis Memphis, TN 901-386-6211 raleightire.com/ ★ 4.6 / 5.0 20 Verified Reviews ♥ 23 Customer Favorites		Vehicle serviced - Tire(s) replaced - Tire(s) balanced - Tires rotated - Tire condition and pressure checked - Four wheel alignment performed
08/20/2021	113,719	Raleigh Tire - Memphis Memphis, TN		Vehicle serviced

901-386-6211
raleightire.com/

★ 4.6 / 5.0

20 Verified Reviews

♥ 23 Customer Favorites

08/31/2021 114,170

Express Oil Change & Tire
Engineers
Bartlett, TN
901-266-9971
expressoil.com

★ 4.8 / 5.0

40 Verified Reviews

♥ 11 Customer Favorites



Vehicle serviced

- Maintenance inspection completed
- Oil and filter changed

12/16/2021

Damage Report



Accident reported

- Damage to front
- Functional damage reported

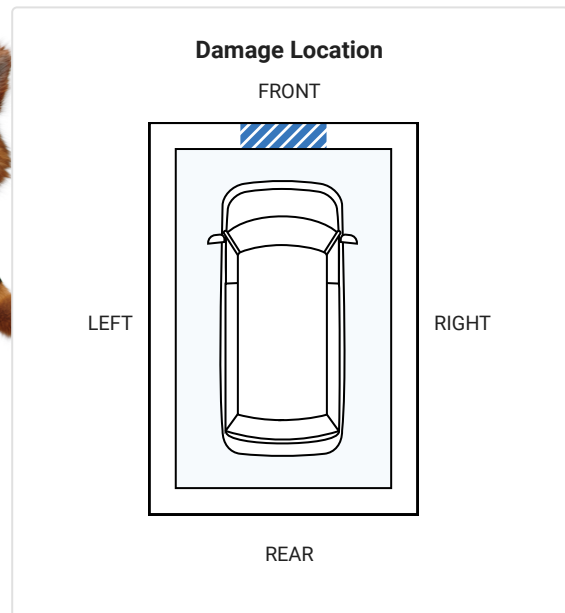

**CARFAX HAS THE MOST
ACCIDENT & DAMAGE
INFORMATION**

02/11/2022

Damage Report



Damage reported: minor damage

- Damage to front
- Damage to right front

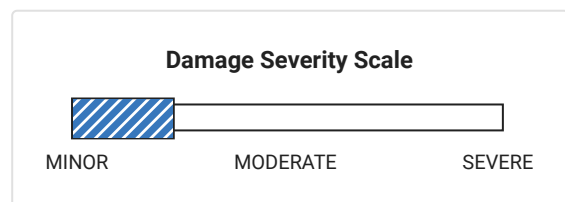

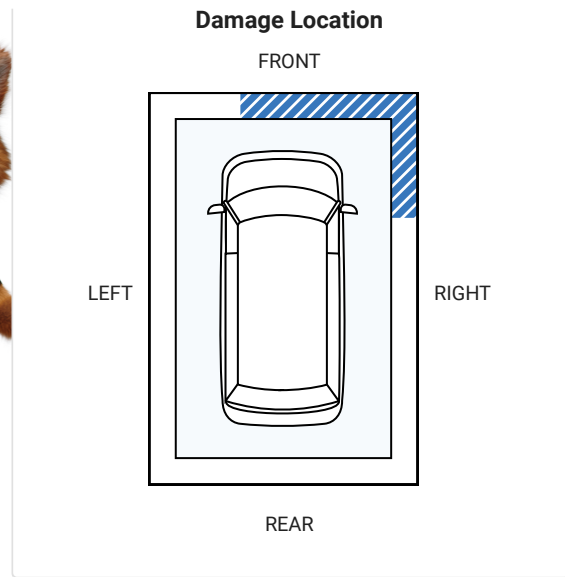

CARFAX HAS THE MOST ACCIDENT & DAMAGE INFORMATION

02/15/2022

Tennessee
Motor Vehicle Dept.
Memphis, TN
Title #96564239

Registration issued or renewed

- Loan or lien reported
- Titled or registered as commercial vehicle
- Vehicle color noted as White

06/08/2022 123,002

Valvoline Instant Oil
Change
Lakeland, TN
901-388-7289
vioc.com



Vehicle serviced

- Oil and filter changed

★ 4.4 / 5.0

134 Verified Reviews

♥ 146 Customer Favorites

01/06/2023

Tennessee
Motor Vehicle Dept.
Memphis, TN
Title #96564239

Registration issued or renewed

- Loan or lien reported
- Titled or registered as commercial vehicle
- Vehicle color noted as White



Avoid financial headaches. Make sure the loan has been paid off if you're buying from a private seller. [Learn More](#)

Have Questions? Consumers, please visit our Help Center at www.carfax.com. Dealers or Subscribers, please visit our Help Center at www.carfaxonline.com.



Glossary

Accident Indicator

CARFAX receives information about accidents in all 50 states, the District of Columbia and Canada.

Not every accident is reported to CARFAX. As details about the accident become available, those additional details are added to the CARFAX Vehicle History Report. CARFAX recommends that you have this vehicle inspected by a qualified mechanic.

- According to the National Safety Council, Injury Facts, 2021 edition, 5% of the 276 million registered vehicles in the U.S. were involved in an accident in 2019. Over 77% of these were considered minor or moderate.
- This CARFAX Vehicle History Report is based only on information supplied to CARFAX and available as of 7/25/23 at 11:41:21 AM (CDT). Other information about this vehicle, including problems, may not have been reported to CARFAX. Use this report as one important tool, along with a vehicle inspection and test drive, to make a better decision about your next used car.

Commercial

Vehicle was registered for business purposes.

Damage Indicator

Damage can be a result of many different types of events. Examples include contact with objects (other cars, trees, traffic signs, road debris, etc), vandalism, or weather-related events. Not every damage event is reported to CARFAX. As details about the damage event become available, those additional details are added to the CARFAX Vehicle History Report. CARFAX recommends that you have this vehicle inspected by a qualified mechanic.

- This CARFAX Vehicle History Report is based only on information supplied to CARFAX and available as of 7/25/23 at 11:41:21 AM (CDT). Other information about this vehicle, including problems, may not have been reported to CARFAX. Use this report as one important tool, along with a vehicle inspection and test drive, to make a better decision about your next used car.

Damage Severity

Damage events result in one of the following severity levels:

- Minor: Generally, minor damage is cosmetic (including dents or scratches), may only require reconditioning, and typically does not compromise a vehicle's operation and/or safety.
- Moderate: Moderate damage may affect multiple components of the vehicle and may impair the vehicle's operation and/or safety.
- Severe: Severe damage usually affects multiple components of the vehicle and is likely to compromise the vehicle's operation and/or safety.

CARFAX recommends getting a pre-purchase inspection at a certified collision repair facility.

First Owner

When the first owner(s) obtains a title from a Department of Motor Vehicles as proof of ownership.

Ownership History

CARFAX defines an owner as an individual or business that possesses and uses a vehicle. Not all title transactions represent changes in ownership. To provide estimated number of owners, CARFAX proprietary technology analyzes all the events in a vehicle history. Estimated ownership is available for vehicles manufactured after 1991 and titled solely in the US including Puerto Rico. Dealers sometimes opt to take ownership of a vehicle and are required to in the following states: Maine, Massachusetts, New Jersey, Ohio, Oklahoma, Pennsylvania and South Dakota. Please consider this as you review a vehicle's estimated ownership history.

Follow Us:



facebook.com/CARFAX



[@CARFAXinc](https://twitter.com/CARFAXinc)



About CARFAX

CARFAX DEPENDS ON ITS SOURCES FOR THE ACCURACY AND RELIABILITY OF ITS INFORMATION. THEREFORE, NO RESPONSIBILITY IS ASSUMED BY CARFAX OR ITS AGENTS FOR ERRORS OR OMISSIONS IN THIS REPORT. CARFAX FURTHER EXPRESSLY DISCLAIMS ALL WARRANTIES, EXPRESS OR IMPLIED, INCLUDING ANY IMPLIED WARRANTIES OF MERCHANTABILITY OR FITNESS FOR A PARTICULAR PURPOSE.

© 2023 CARFAX, Inc., part of S&P Global. All rights reserved.
7/25/23 11:41:21 AM (CDT)

I have reviewed and received a copy of the CARFAX Vehicle History Report for this 2014 RAM C/V vehicle (VIN: 2C4JRGAG0ER148130), which is based on information supplied to CARFAX and available as of 7/25/23 at 12:41 PM (EDT).

Customer Signature

Date

Dealer Signature

Date